

Dear Stella fabrics are available online and in sewing and quilting shops worldwide. Ask for it at your local quilt shop!

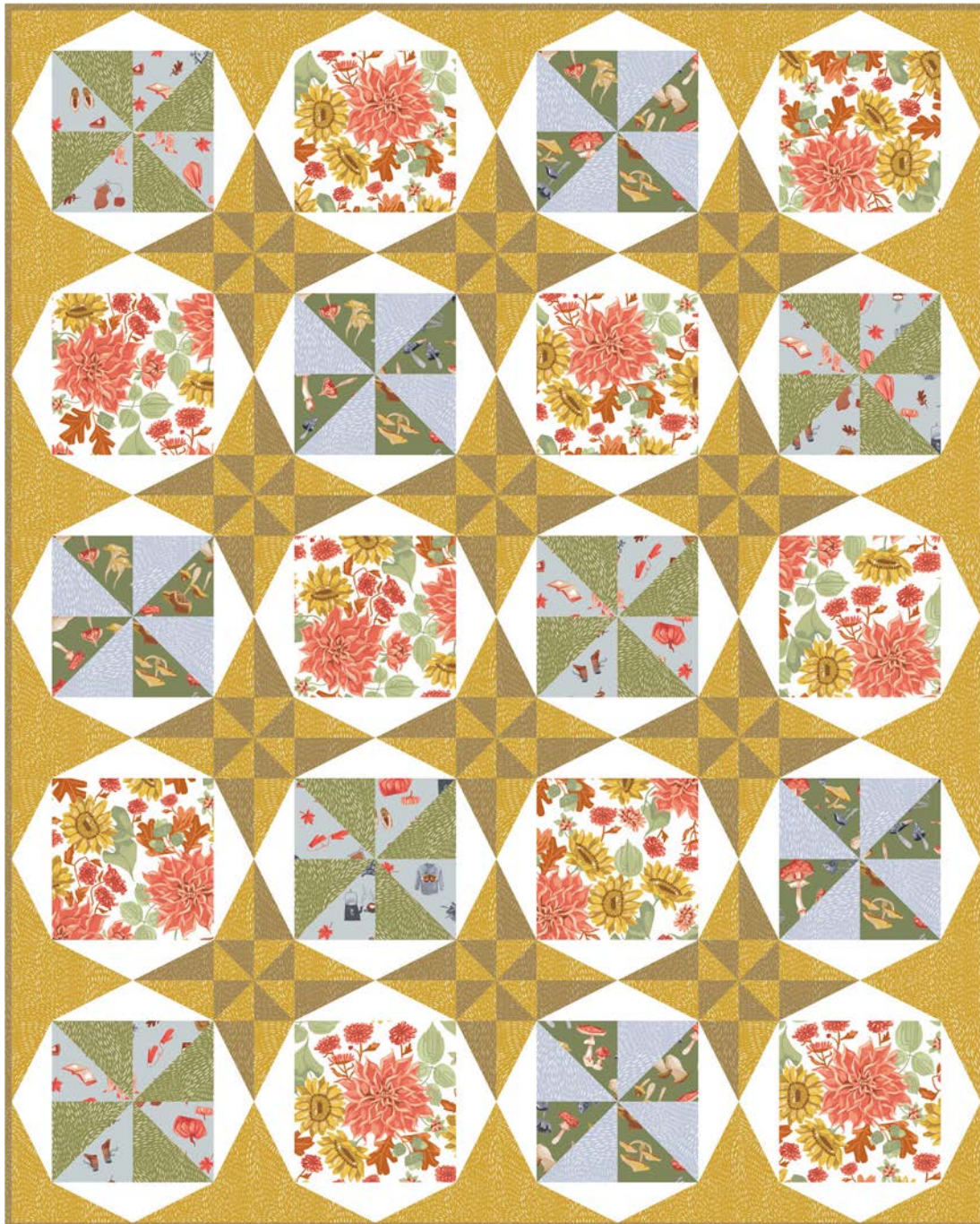

Finished quilt size: 48¹/₂" x 60¹/₂"

Starflight

quilt pattern

DESIGNED BY Elisabeth Hardy
elisabewquilts.com

Featured fabrics: Hygge

by

Rae Ritchie









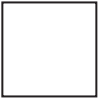
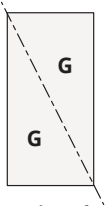

Quilt glow! Clever piecing and strategic fabric placement create a secondary star pattern in this fun design. We love how it shines in Rae Ritchie's *Hygge* collection. Don't you?

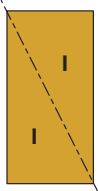
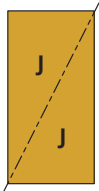

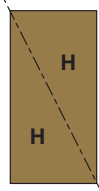
This pattern is owned and licensed by Dear Stella for personal use only and should not be reproduced for sale to any third party.

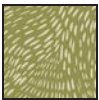
www.dearstelladesign.com

STARFLIGHT QUILT PATTERN

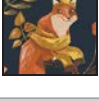
Materials and Cutting		
Fabric	Yardage	Cutting
 Stella Solids Stella-solid White	1 1/4 yards	Cut: 7 strips, 6" x width of fabric (WOF). Sub-cut 80 rectangles, 3" x 6". Sub-cut each rectangle once diagonally, to make 160 G triangles.  G triangle Make 160.
 Dash Flow Stella-SRR1300 Amber	1 1/4 yards	Cut: 2 strips, 3" x WOF. Sub-cut 24 E squares, 3" x 3". 2 strips, 2 1/2" x WOF. Sub-cut 32 L squares, 2 1/2" x 2 1/2". 5 strips, 6" x WOF. Sub-cut 56 rectangles, 3" x 6". Sub-cut 16 rectangles once diagonally, from upper left to lower right, to make 32 I triangles. Sub-cut the remaining 40 rectangles once diagonally, from lower left to upper right to make 80 J triangles.   I triangle J triangle Make 32. Make 80.
 Dash Flow Stella-SRR1300 Almond	1 yard	Cut: 2 strips, 3" x WOF. Sub-cut 24 F squares, 3" x 3". 2 strips, 6" x WOF. Sub-cut 24 rectangles, 3" x 6". Sub-cut the rectangles once diagonally, from upper left to lower right to make 48 H triangles. 6 strips, 2 1/4" x WOF, for binding.  H triangle Make 48.
 Autumn Floral Stella-SRR1283 White	7/8 yard	Cut: 3 strips, 8 1/2" x WOF. Sub-cut 10 K squares, 8 1/2" x 8 1/2".
 Dash Flow Stella-SRR1300 Sage	1/3 yard	Cut: 2 strips, 5" x WOF. Sub-cut 10 B squares, 5" x 5".
 Dash Flow Stella-SRR1300 Starlight	1/3 yard	Cut: 2 strips, 5" x WOF. Sub-cut 10 C squares, 5" x 5".
 Mushrooms Stella-SRR1284 Moss	1/3 yard	Cut: 2 strips, 5" x WOF. Sub-cut 10 D squares, 5" x 5".
 Hygge Kit Stella-SRR1282 Canal	1/3 yard	Cut: 2 strips, 5" x WOF. Sub-cut 10 A squares, 5" x 5".
 Getting Hygge With It Stella-SRR1281 Astral	3 yards	Remove selvages and cut: 1 strip, 36" x WOF. Sub-cut two large rectangles, 20" x 36" for backing.
Other		
Batting	56" x 68"	

TIP
 Stay organized!
 Label pieces as
 they are cut. Take
 care not to distort
 bias-cut edges.



STARFLIGHT QUILT PATTERN

Note: All seam allowances are 1/4" unless otherwise specified. Press seam allowances open unless otherwise indicated.

Make the HST

1 Draw a diagonal line from corner to corner on the wrong side of each **A** square. Place one marked **A** square right sides together with one **B** square, aligning outer edges. Sew 1/4" away from each side of the marked line. Cut along the marked line and press the seams open. Square and trim each half-square triangle (HST) to 4 1/2" square. Make a total of 20 **A/B** HST.

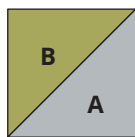
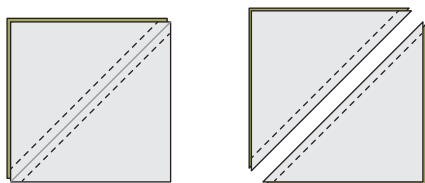

A/B HST
Make 20.

2 Repeat step 1, using **C** and **D** squares. Make 20 **C/D** HST.

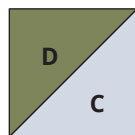

C/D HST
Make 20.

3 Repeat step 1, using **E** and **F** 3" squares. Square and trim each HST to 2 1/2" square. Make 48 **E/F** HST.



E/F HST
Make 48.

Make the Pinwheels

1 Arrange four matching HST in two rows of two units each as shown. Sew the HST in each row together along adjacent edges. Press. Sew the rows together, matching seamlines. Press. Make 5 **A/B** and 5 **C/D** Pinwheels.

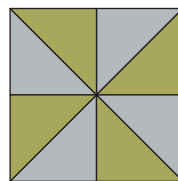
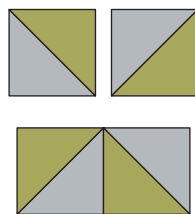

A/B Pinwheel
Make 5.

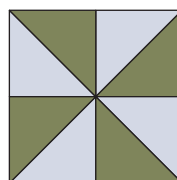

C/D Pinwheel
Make 5.

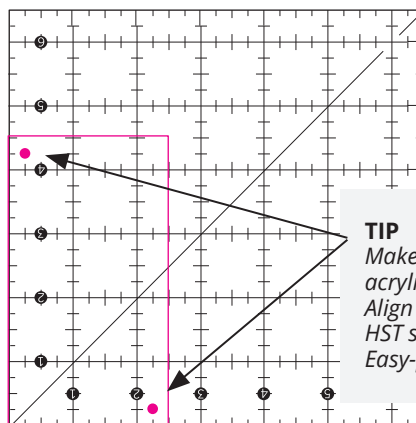

TIP

Make it easy to trim HSR by marking your acrylic ruler 1/4" inside the desired cut size. Align the marked points with the HST seamline, and trim the HST as needed. Easy-peasy!

Make the HSR

1 With right sides together, align one **G** and one **H** triangle along the long diagonal edge, offsetting the triangle tips by 5/8". Sew along the diagonal edge and press the seam allowances toward the darker fabric. Use a clear acrylic ruler and rotary cutter to trim the half-square rectangles (HSR) to 2 1/2" x 4 1/2". Note that the seamline is offset from the diagonal in an HSR and does not run from point to point, as in an HST. Make a total of 48 **G/H** HSR.

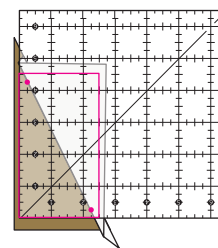
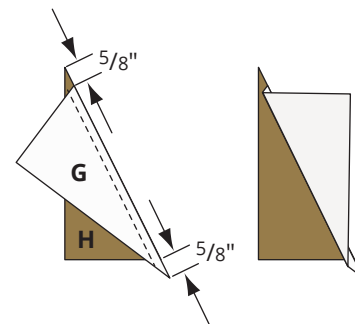

G/H HSR
Make 48.

2 Repeat step 1, using the triangle combinations indicated below, to make 32 **G/J** and 80 **G/I** HSR.



G/J HSR
Make 32.



G/I HSR
Make 80.

#dearstella

Follow dearstellafab on Instagram

and see what's new!



This pattern is owned and licensed by Dear Stella for personal use only and should not be reproduced for sale to any third party.

www.dearstelladesign.com

STARFLIGHT QUILT PATTERN

Make the Blocks

1 To make the Corner blocks, arrange one **A/B** Pinwheel or **K** square, four **G/I** HSR, three **G/J** HSR, one **G/H** HSR, one **L** squares, and one **E/F** HST in three rows as shown.

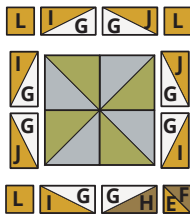

Join the HSR in each row along adjacent edges. Press. Join the elements in each row together along adjacent edges. Press. Join the rows together along adjacent edges, matching seamlines. Press. Make two corner blocks with **A/B** Pinwheel centers, and two corner blocks with **K** square centers.

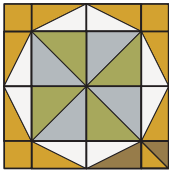

**A/B Pinwheel
Corner Block**
Make 2.

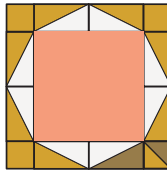

**K Square
Corner Block**
Make 2.

2 To make the edge blocks, arrange one Pinwheel or **K** square, four **G/I** HSR, two **G/J** HSR, two **G/H** HSR, two **L** squares, and two **E/F** HST in three rows as shown. Join the HSR in each row together along adjacent edges. Press. Join the elements in each row together along adjacent edges. Press. Join the rows together along adjacent edges, matching seamlines. Press. Make one edge block with an **A/B** Pinwheel center, four edge blocks with **C/D** Pinwheel centers, and five edge blocks with **K** square centers.

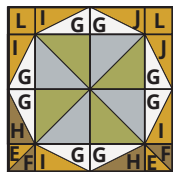

**A/B Pinwheel
Edge Block**
Make 1.

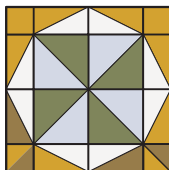

**C/D Pinwheel
Edge Block**
Make 4.

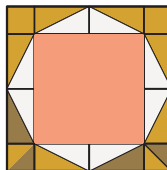

**K Square
Edge Block**
Make 5.

3 To make the center blocks, arrange one Pinwheel or **K** square, four **G/H** HSR, four **G/J** HSR, and four **E/F** HST in three rows as shown. Join the HSR in each row together along adjacent edges. Press. Join the elements in each row together along adjacent edges. Press. Join the rows together along adjacent edges, matching seamlines. Press. Make two center blocks with **A/B** Pinwheel centers, one center block with a **C/D** Pinwheel center, and three center blocks with **K** square centers.

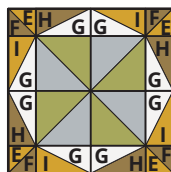

**A/B Pinwheel
Center Block**
Make 2.

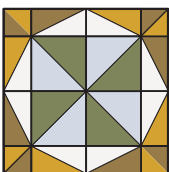

**C/D Pinwheel
Center Block**
Make 1.

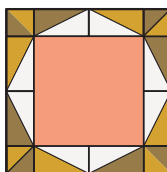

**K Square
Center Block**
Make 3.

Assemble the Quilt

1 Referring to the quilt photo for block placement and orientation, arrange the blocks in five rows of four blocks each. Join the blocks in each row together along adjacent edges, matching seam lines. Press.

2 Join the rows together in order along adjacent edges. Press the seams in one direction.

Finishing

1 Using a 1/2" seam allowance, join the two large backing rectangles along one short edge. Press. Join the rectangles to the remaining backing yardage along one long edge to complete the quilt backing. Press.

2 Layer the quilt backing, batting, and quilt top. Quilt as desired. Stitch a scant 1/4" from the edge around the perimeter of the quilt. Trim the excess backing and batting. Use your favorite method to bind the quilt.

